

AQUATICS



**OBL2-PRO**

Omega Backstroke Ledge  
User's Manual

**3454.521.02**

Version 1.3

Edition May 2023

---

## Caution and safety precautions

- Never use any other charger than the supplied or a type approved by Swiss Timing. This could destroy the battery, cause damage to unit, and possible cause personal injury due to fire or/and electrical shock.
- Never bypass a power cord ground lead by breaking off the ground pin, or by using inappropriate extension cords or adapters.
- Never plug a power cord into the AC power source until you have made sure that all installation, cabling and power levels, are proper, and that the applicable procedures in this manual have been followed.
- Protect the equipment against splashing, rain and excessive sun rays.
- Never use the device if it is damaged or insecure.
- Verify the selection of the power distribution.
- Verify that the voltage quoted on the rating plate is the same as your voltage. Connect the appliance only to power sockets with protective earth. The use of incorrect connection voids warranty.
- This program may be modified at any time without prior notification.
- Do not open the case; there is nothing that needs servicing inside it. Nevertheless, if the case must be opened, you must call for some qualified personnel. The power supply cable must be disconnected before opening the case.
- During the transport of all Swiss Timing equipment delivered with a reusable carry case, the said case should be used at all times. This is imperative to limit the damage, such as shocks or vibration that can be caused to the units during transport.
- The same cases should also be used when returning equipment to Swiss Timing for repair. Swiss Timing reserves the right to refuse all guarantees if this condition is not fulfilled.
- If the installation includes a horn, be sure to maintain a sufficient security distance from the public.

## Documentation Updates

Swiss Timing Ltd. reserves the right to make improvements in the products described in this documentation at any time without prior notice. Furthermore, Swiss Timing Ltd. reserves the right to revise this documentation in its content at any time and without any obligation to notify any person or organization of such revision.

## Disclaimer

The information provided in this documentation has been obtained from sources believed to be reliable, accurate and current. However, Swiss Timing Ltd. makes no representation or warranty, express or implied, with respect, but not limited to, the completeness, accuracy, correctness and actuality of the content of this documentation. Swiss Timing Ltd. specifically disclaims any implied warranty of merchantability, quality and/or fitness for any particular purpose. Swiss Timing Ltd. shall not be liable for errors contained in this documentation or for incidental or consequential damages in connection with the supply, performance or use of this documentation.

## Environment



This symbol indicates that this product should not be disposed with household waste. It has to be returned to a local authorized collection system. By following this procedure you will contribute to the protection of the environment and human health. The recycling of the materials will help to conserve natural resources.

## Copyright

© Swiss Timing Ltd.

All rights reserved.

This documentation may not, as a whole or in part, be copied, translated, reproduced, transmitted or reduced and/or stored to any electronic medium or machine-readable form without the prior written consent of Swiss Timing Ltd.

---

## TABLE OF CONTENTS

<b>1</b>	<b>INTRODUCTION</b> .....	<b>1</b>
<b>2</b>	<b>PRECAUTIONS AND WARNING</b> .....	<b>1</b>
2.1	Before using the Backstroke Ledge .....	1
2.2	Using the Backstroke Ledge .....	1
<b>2.3</b>	<b>Safety rule for Backstroke Ledge</b> .....	<b>2</b>
<b>3</b>	<b>PRODUCT DESCRIPTION</b> .....	<b>3</b>
3.1	Components description .....	3
<b>4</b>	<b>FINA – HOW TO USE</b> .....	<b>4</b>
<b>5</b>	<b>INSTALLATION AND SETTINGS</b> .....	<b>5</b>
<b>6</b>	<b>USE IN COMPETITION</b> .....	<b>8</b>
<b>7</b>	<b>PERSONAL ADJUSTMENTS</b> .....	<b>9</b>
<b>8</b>	<b>STORAGE AND MAINTENANCE</b> .....	<b>10</b>
<b>9</b>	<b>TECHNICAL CHARACTERISTICS</b> .....	<b>10</b>
9.1	Dimensions and weight.....	10
<b>10</b>	<b>FAQ AND FAILURE SOLUTIONS</b> .....	<b>11</b>
<b>11</b>	<b>APPENDIX</b> .....	<b>11</b>
11.1	Version history .....	11



## 1 INTRODUCTION

The **Omega Backstroke Ledge (OBL2-Pro)** is the ideal complement to the **Omega Starting Blocks OSB11, OSB12 and OSB14** for the backstroke swimming. This device has been fully developed according to the FINA rules (handbook 2013 – 2017). OBL2-Pro allows the best starts for backstroke swimming competitions of all levels and categories.

**Simply/easily mounted:** it can be used during the entrance in the water and once the race has begun it can be removed not to bother the swimmers during the competition.

**Help psychologically the backstroke swimmer:** this new device gives swimmers the assurance they did not have before when entering the water. This takes away pressure before starting the competition thanks to the anti-skid surface that covers the footrest. It allows a better grasp to the backstroke swimmers when entering the water.

**Adjustable according to the swimmer's choice of start position.**

**Better power and force when entering the water:** thanks to the Backstroke Start, the swimmers gain in power and force when entering the water. Through the training with this device, swimmers gain confidence and perform better.

You now have the opportunity to improve your backstroke swimming performance. See for yourself how many milliseconds you can gain at the start!

Please read this manual carefully before starting to use your **Backstroke Ledge**.

## 2 PRECAUTIONS AND WARNING

### 2.1 Before using the Backstroke Ledge

Always check the unit to verify the full integrity of all the parts. If a single component is broken, gets loose or shows cracks, **DO NOT USE** the device.

### 2.2 Using the Backstroke Ledge

You must train a lot before each competition to progressively acquire all the skills to control your backstroke start. Before each start, always make sure that there are no obstacles that you might hit. Consider that with the Backstroke Ledge your starting jump is much longer than usual.

All the components of this unit are designed with the utmost care for the safety of all the users (no burrs, no sharp edges, etc.) but ultimately the most relevant factor is your own attention.

Never use the Backstroke Ledge for any sport, activity or task this product is not designed for. Only the proper use of the Backstroke Ledge is described in this manual. Do not leave this product to unsupervised children. Do not expose the backstroke Ledge to fire or to high temperature sources (e.g. do not lay the product on a radiator to dry).

To preserve the device, do not use aggressive cleaners or solvents (e.g. Acetone) which could damage the surface of the ABS components. Refer to chapter 8 (STORAGE AND MAINTENANCE) for details.

**2.3 Safety rule for Backstroke Ledge**

Improper use of Backstroke Ledge could damage it.

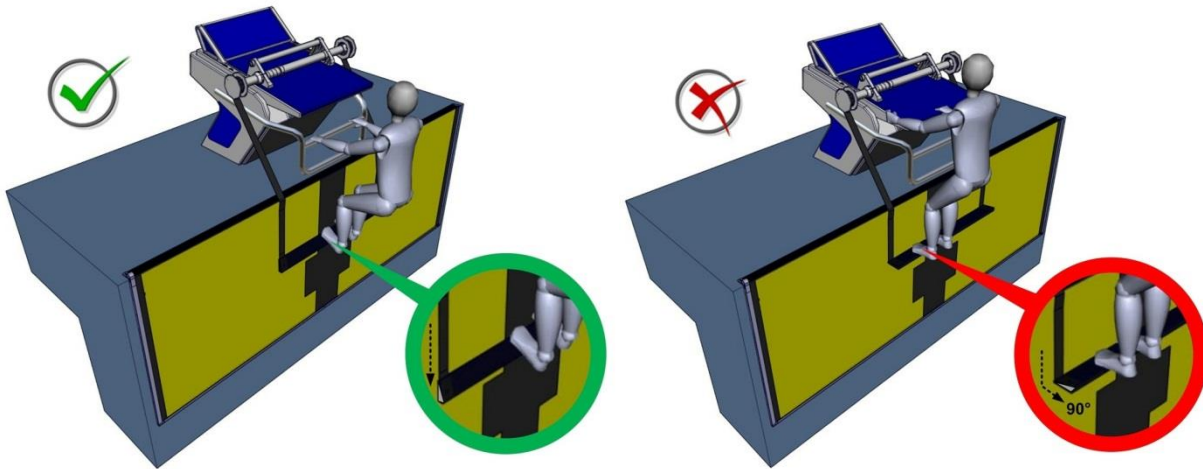

**Never put pressure on the Backstroke Ledge when it is in a 90° position.**

In order to guarantee the stability of the unit, both straps have to be positioned under the rims, as shown in picture **P09**

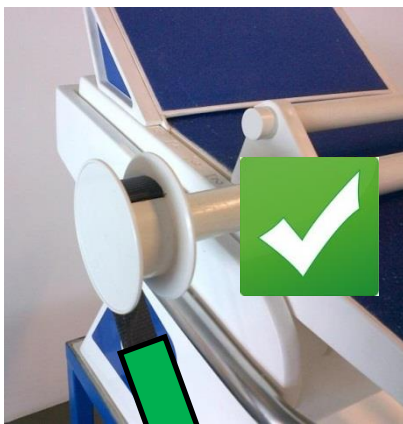

  
**STRAPS ARE POSITIONNED UNDER THE RIMS**

**P09**

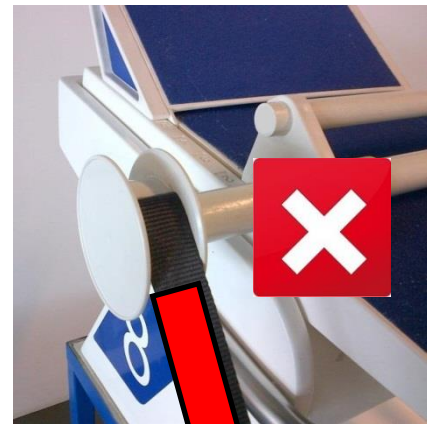

**P10**

**Never position the straps like in picture **P10** because the unit could unhook at the start.**

### 3 PRODUCT DESCRIPTION



The Backstroke Ledge is fully compatible with Omega OSB11, OSB12 and OSB14 (  Facilities rules / FR2.7 / “**The height of the platform above the water surface shall be from 0.5 metre to 0.75 metre**”). You have received a product fully assembled and ready to use once unpackaged. Each unit consists of a lower part (which must lean against the end wall of the pool) including a footrest designed to support the swimmer’s push at the start and an upper part to hook the assembly to the starting platform. The upper part also includes a rotating mechanism (Patent Pending) to set the unit to your own starting position and to your size. A return spring allows a “one hand” easy adjustment, also for the athlete in water. The upper handlebar allows an easy grab of the unit for a quick removal after the start.

Using this device, the angle between the legs and the water surface during the final push off the wall is greater. As a result, the swimmer’s feet travel the path during the start phase of flight with less contact with the water.

#### 3.1 Components description

- 1** Footrest – 3454.110
- 2** Straps
- 3** Rims – 3454.111
- 4** Bars
- 5A** Left Support – 3454.120
- 5B** Right Support – 3454.121
- 6A** Left Protection Membrane – 3454.114
- 6B** Right Protection Membrane – 3454.115
- 7** Adjustment ring – 3454.119
- 8** Spring
- 9** Locking ring
- 10** Yellow warning label – 3454.117
- 11** Protection cap – 3454.118

#### Other components

- Metric hexagonal Allen key N°4  **P05**
- Safety clasp - 3454.116 (Chapter 5 / Picture **P11**)  **P06**

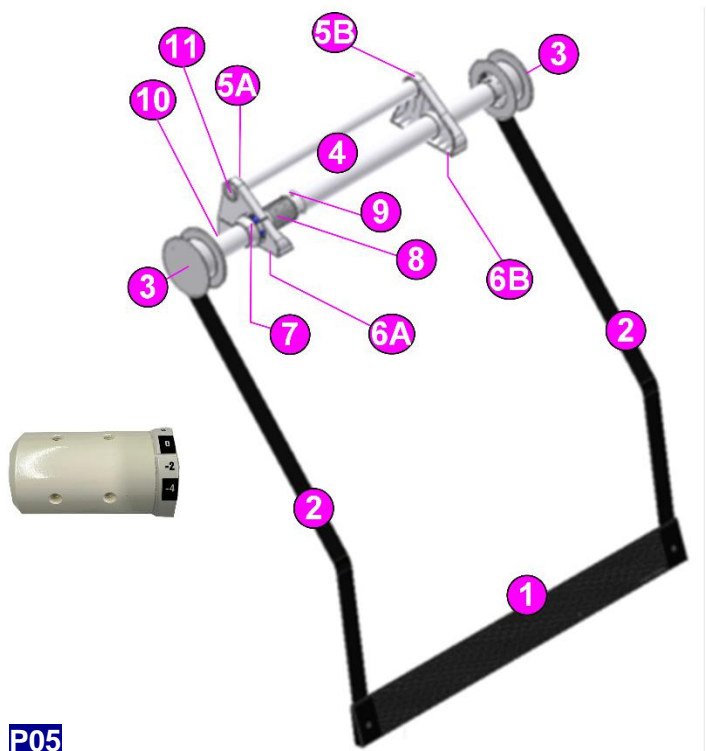



## 4 FINA – HOW TO USE

- At the start, the toes of both feet must be in contact with the end wall or face of the touchpad. Bending the toes over the top of the touchpad is prohibited.

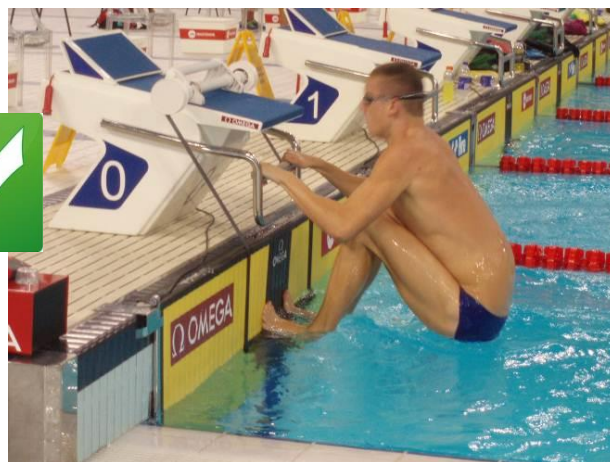

- The ledge may be adjusted to 4 cm above or 4 cm below the water level in steps of 2 cm.
- The ledge is a minimum of 65 cm in length.
- The ledge must be 8 cm in height, 2 cm at the maximum thickness with 10 degrees of slope.





## 5 INSTALLATION AND SETTINGS

The Backstroke Ledge has to be installed on the starting platform top, as shown in picture **P07**.

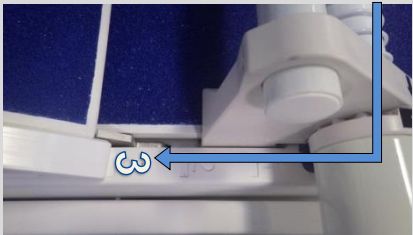
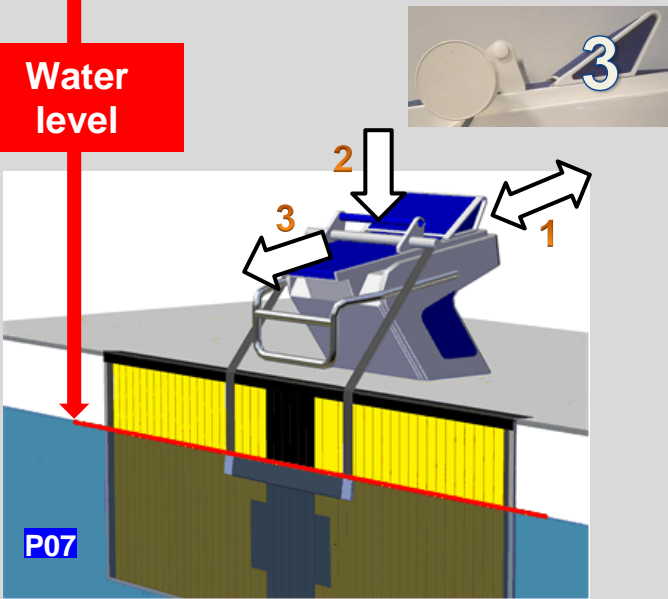

Normally the water filtering system (pump) is off during races, it is therefore required to ask for stopping the filtering system in order to properly perform the water level setting.

The water level rises about 2cm when the filtering system is on.

<p>1</p>	<p>Put OSB footrest to position <b>3</b></p> 	
<p>2</p>	<p>The two fins of the supports <b>5</b> have to be inserted into the top slots.</p>	
<p>3</p>	<p>Then the unit must slide forward, until it can't slide further.</p>	
<p>4</p>	<p>The adjustment ring must be positioned on your right. (view from the back of the OSB).</p> 	

Check if backstroke rear is parallel to slot marking and positioned between 1 and 2.

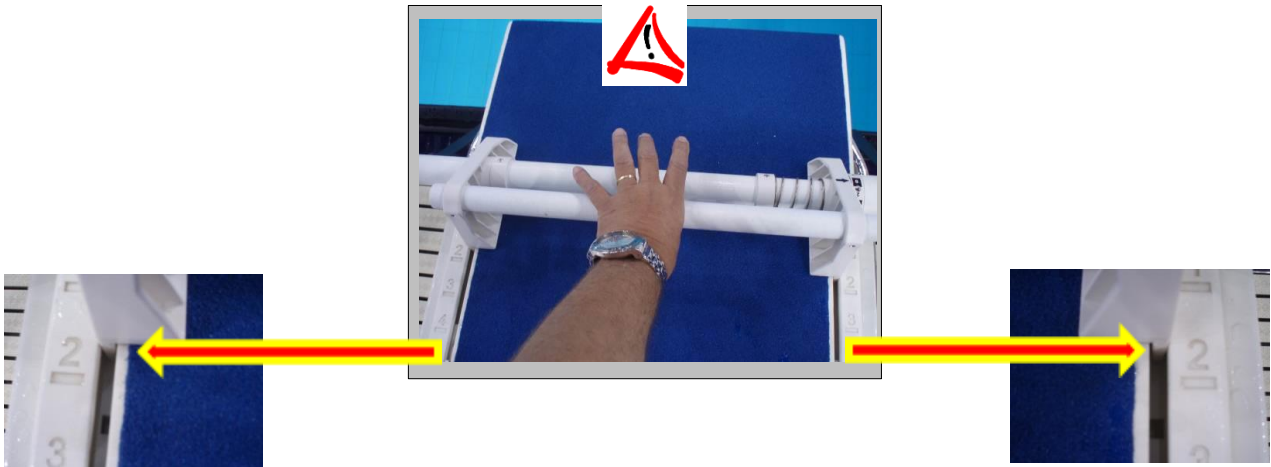

The Backstroke Ledge footrest should be already set at the water level, if it is not the case proceed as follows:

- Select position **0** of adjustment ring **7** in front of black arrow.
- Release the four screws of the adjustment ring **7** (**A** and **B** in picture **P08**) with the provided Hexagonal Allen key, then unroll the footrest **1** downwards.
- Rewind the straps rotating the rims in the direction shown in picture **P08** by the green arrows, until the upper edge of the footrest is at water level.
- Tighten the screws of the adjustment ring **7** keeping the **0** aligned with the index of the support beside.

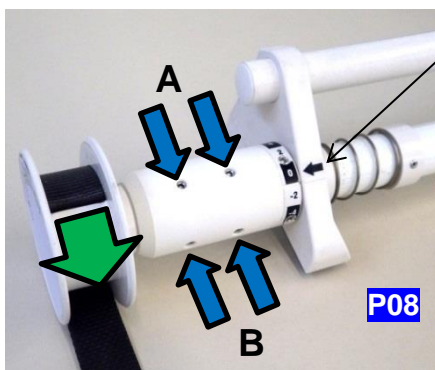

Black arrow

If the adjustment ring is small, only use two screws. **A'** and **B'**

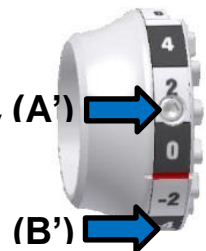

Do not force the screws too much ; the suggested maximum torque to avoid breakages is **3Nm**.

In order to guarantee the stability of the unit, both straps have to be positioned under the rims, as shown in picture **P09**

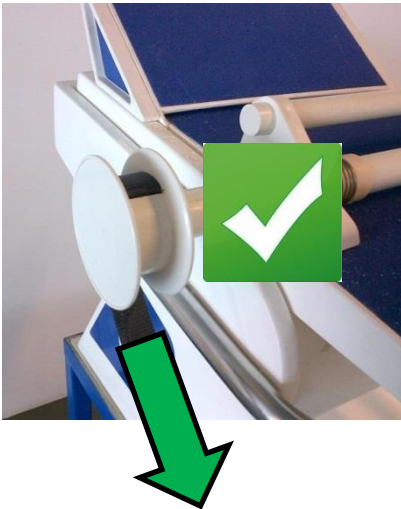

STRAPS ARE POSITIONED UNDER THE RIMS

P09

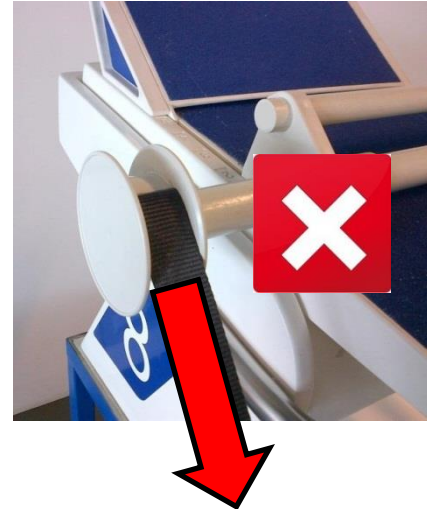

P10

**Never position the straps like in picture P10 because the unit could unhook at the start.**

A safety clasp is mounted on the right rim (view from the rear of the OSB) in order to rewind and position the strap correctly P11.

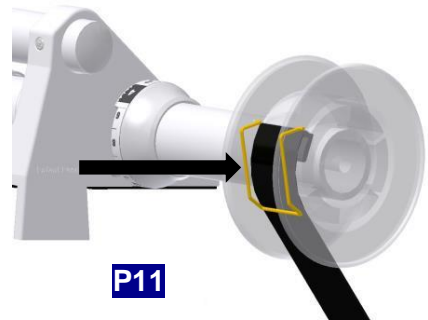

Before each competition, make sure the safety clasp is in place. If safety clasp is missing, replace it immediately.

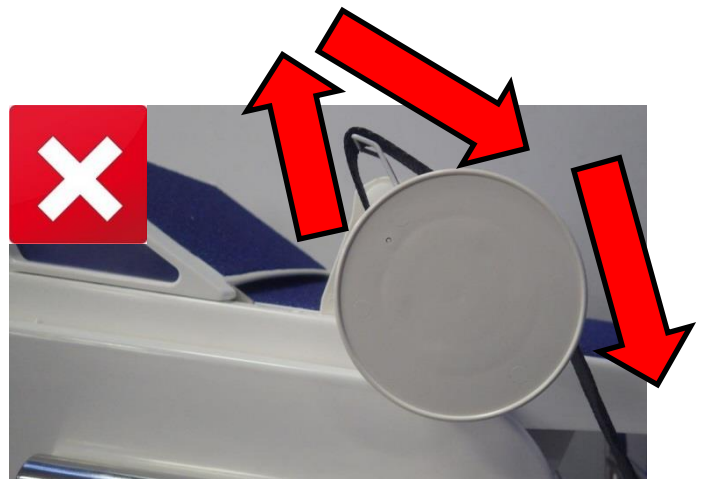

## 6 USE IN COMPETITION

**Before the competition** all the units have to be properly installed as described above. The referees are responsible for verifying the compliance of the installation with the competition rules.

**Before the start** each athlete can adjust the footrest into position as described in chapter 7 (PERSONAL ADJUSTMENTS). Eventual limitations of the adjustment range are out of the scope of this User Manual.

	<b>Always verify that the straps unroll under the rims, as shown in picture <a href="#">P09</a></b>
	<b>Check that the straps are well stretched and that the footrest bar stays in horizontal position.</b>

**After the start** the assigned officials (e.g. the inspectors of turns) shall immediately remove the Backstroke Ledge units from the starting blocks, in order to clear the end walls (or the touchpads) to allow the turns.

The removal operation is quick and easy:

- **Lift the upper handlebar and put the system aside, on the deck.**
- or
- **Lift the footrest and place it behind the footrest of the OSB.**



## 7 PERSONAL ADJUSTMENTS

The adjustment feature is fundamental to adapt the starting position to each swimmer's level, style, age and size.

The adjustment can also be achieved from the water, grabbing the bar with the left hand and pulling to the left (A) to unlock the mechanism.

Once rotated to the suitable position (B) with the reference of the numerical scale, the spring helps to recall the mechanism.

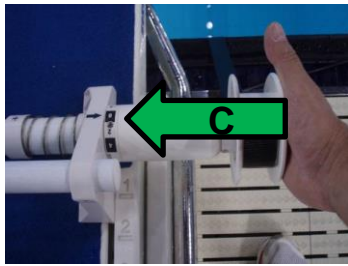

Secure by pushing with your hand(C)

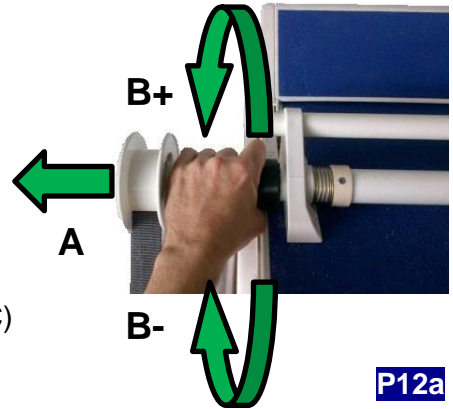

P12a

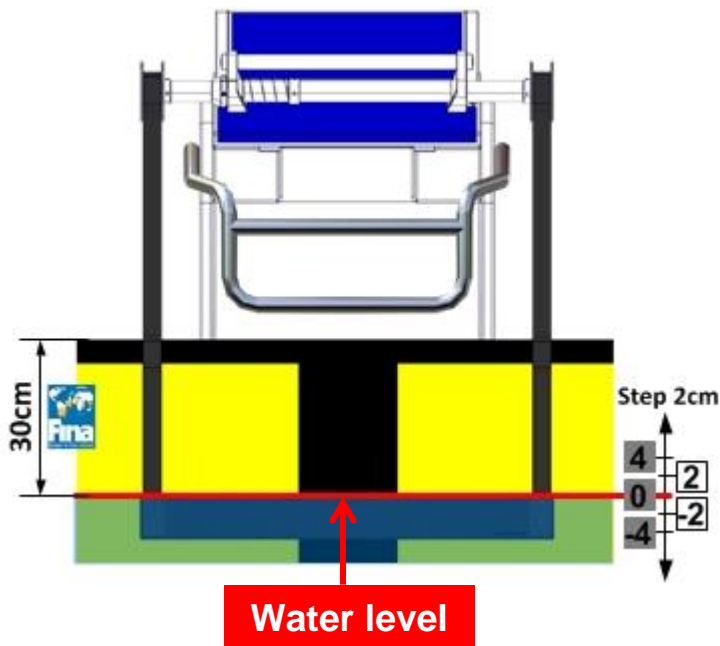

Five positions are allowed by the standard unit. From the **water level (position 0)** the footrest can be lifted up 2 to 4 cm, or plunged -2 to -4 cm.

P12b

Note that by removing the locking screw indicated in picture P12c, more positions are possible, by steps of 2cm. The use of those additional positions should be allowed considering the competition rules, as well as the end wall and the touchpads' specifications.

Anyway the acceptance of additional adjustment positions is out of the scope of this User Manual.

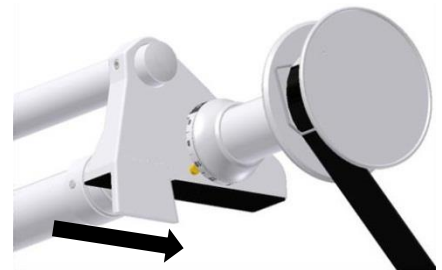

P12c



## 8 STORAGE AND MAINTENANCE

In order to preserve your Backstroke Ledge as long as possible, rinse the unit after each use with fresh water (remove the chlorinated water of the pool). Before the storage, verify that the unit is perfectly dry.

Periodically check if any oxidation has developed on the stainless steel components (screws, springs). Although made of high quality stainless steel, some traces of rust could appear when exposed to aggressive environments (e.g. salted water). If necessary, clean gently: soapy water or a mild detergent is usually safe and successful.

Take the same care of the ABS components to preserve the original colour and appearance. A damp cloth or chamois leather will usually be suitable for cleaning and drying.

Do not store the unit under heavy objects which may deform the plastic components.

After an eventual severe impact or drop, check if the unit is damaged and, in case of any doubt, do not take the risk of using it.



**Always avoid aggressive cleansers as hypochlorite bleaches, chloride-containing cleansers, 95° alcohol, acetone and any other solvents or unsuitable chemical substances.**

## 9 TECHNICAL CHARACTERISTICS

### 9.1 Dimensions and weight

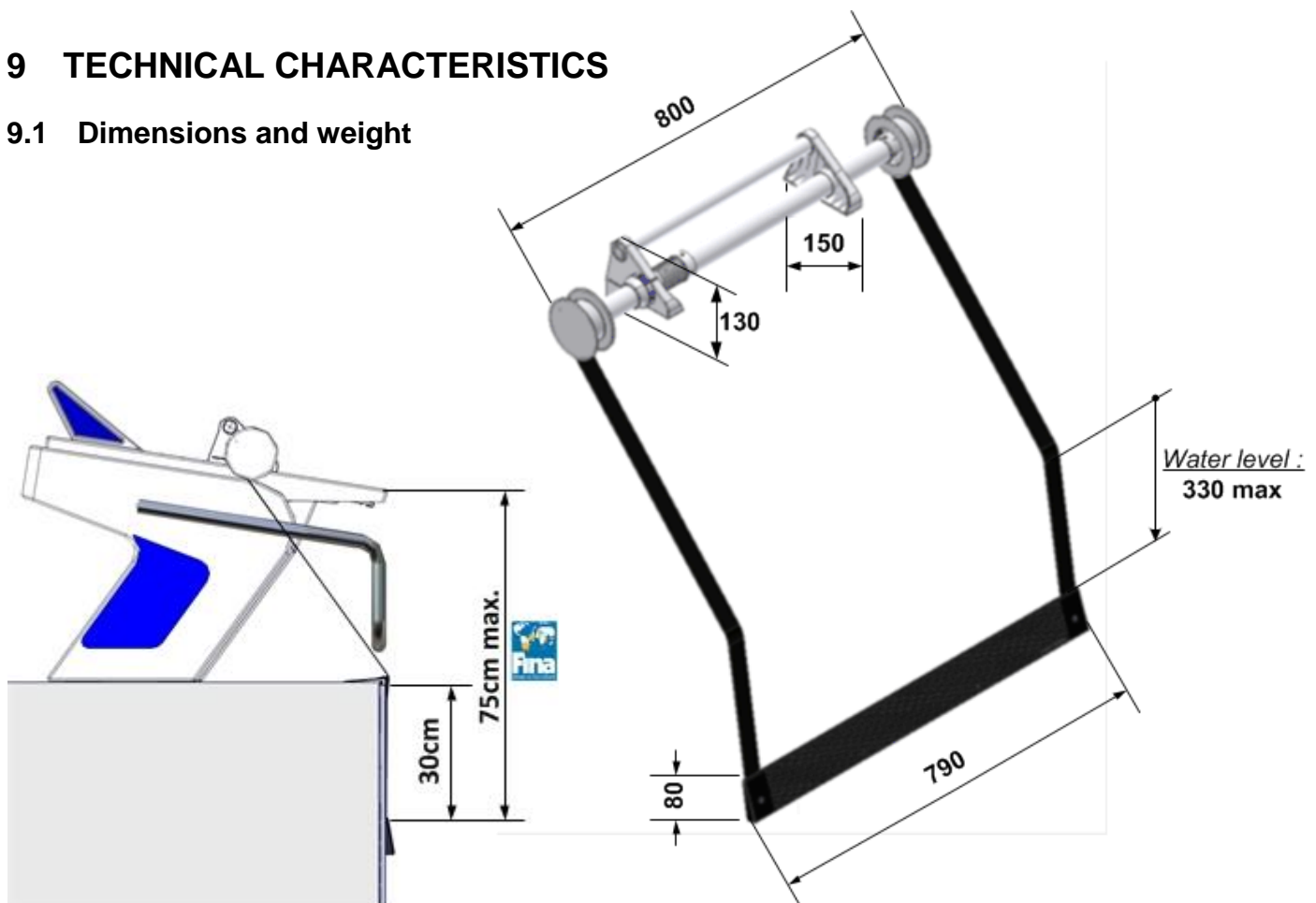

Dimensions / Dimensions / Grösse (mm):

Weight / Poids / Gewicht (kg):

800 x 150 x 130

3.9



## 10 FAQ AND FAILURE SOLUTIONS

Is this product compliant with the FINA / LEN rules?

- Yes

One protection membrane **6A or 6B** got unstuck. Can I fix it?

- Yes

Glue the protection membrane on the base of the support, using a common cyanoacrylate instant adhesive.

## 11 APPENDIX

### 11.1 Version history

Version	Modifications since last version
1.0	Initial version
1.1	Global modifications
1.2	Components description updated on chapter 3.1
1.3	Figure and component description updated on chapter 3.1

## NOTES



